

Fiberglass Tubs



Clarion gel-coated fiberglass units are manufactured using state-of-the-art spray-up method. Each unit receives 16-18 mills of gel-coat, two layers of fiberglass laminate, and extra reinforcing in stress areas. The products meet or exceed the requirements of the American National Standards Institute, National Association of Home Builders, Z 124.1 and Z 124.2 or W/WP541/3A or WWR-541 and FHA/HUD-UM73

Fiberglass Standard Tub



A sloped bathing well makes efficient use of small space with a clean, simple design. Left or right hand drain. 54" x 28" x 17-3/4". (Note: these models do not have predrilled overflow hole.)

- 379070** LH - Bone
- 379071** LH - White
- 379072** RH - Bone
- 379073** RH - White

Not Stocked At All Locations



Fiberglass Garden Tub



A relaxing bathing experience awaits in this bath. Fixtures can be placed on the left or right surrounding ledges. A convenient slip-resistant step/seat allows easy access. A natural for whirlpool, this unit can be jetted. Center drain.

With Step

- 379940** 48-3/4" x 60" x 24-3/4" with Step - Bone
- 379939** 48-3/4" x 60" x 24-3/4" with Step - White
- 379936** 54" x 42-1/4" x 24-3/4" with Step - Bone
- 379935** 54" x 42-1/4" x 24-3/4" with Step - White

Without Step

- 379938** 43" x 60" without Step - Bone
- 379937** 43" x 60" without Step - White

Not Stocked At All Locations

3-Pc. Tub and Surround

Tub and surround in three simple sections. 54" W x 28" D x 75" H. Center drain.

- 379080** Bone
- 379081** White

Not Stocked At All Locations

Fiberglassed Composite Tubs/Surrounds

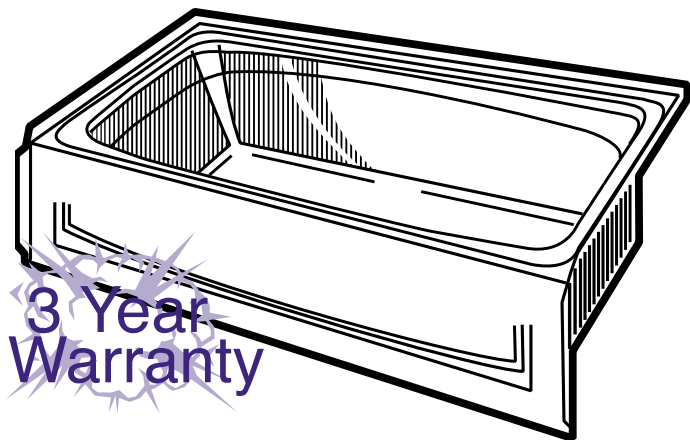

Fiberglass with Composite Technology for Strength and Beauty

- ▲ High gloss finish
- ▲ Hard plastic surface
- ▲ Scratch resistant
- ▲ Reinforced
- ▲ Prevents flex
- ▲ Adds thickness

Standard Tubs

One-piece tub with integrated apron and textured bottom. Three-year warranty. Individually boxed. 27" x 54" x 15" with 1" lip.

- 379850** White, LH Drain
- 379852** White, RH Drain
- 379851** Bone, LH Drain
- 379853** Bone, RH Drain
- 379858** White, Center Drain
- 379859** Bone, Center Drain

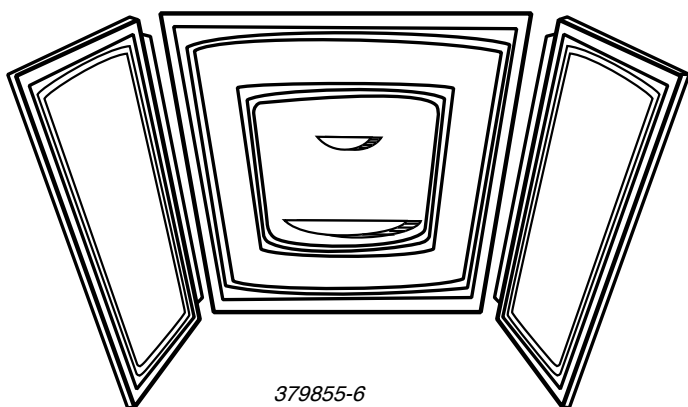

379855-6

3-Pc. Surrounds

Interlocking panels with smooth gloss finish. 27" D x 54" W x 59.5" H.

- 379855** White
- 379856** Bone

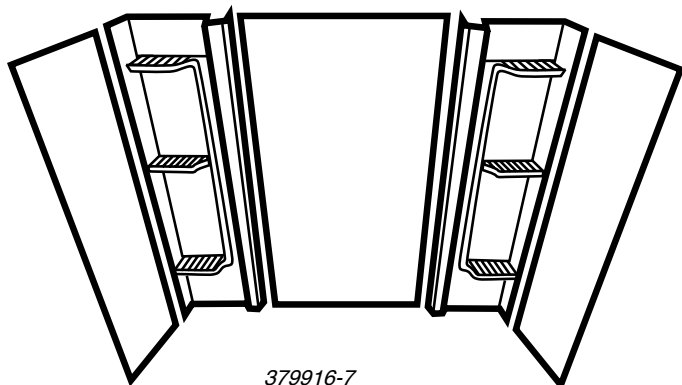

379916-7

5-Pc. Surrounds

High-gloss finish, 6 accessory shelves. 27" D X 54" W X 59" H.

- 379916** Bone
- 379917** White

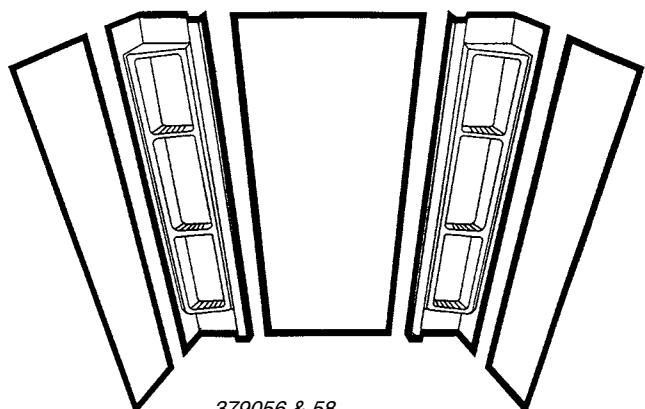

379056 & 58

5-Pc. Garden-Tub Surrounds

High-gloss finish, 6 accessory shelves. Easily cut to fit depths from 42" to 48". 60" W x 59" H.

- 379058** Bone
- 379056** White

Fiberglassed Composite Tubs/Surrounds

2 Pc. Tub & Surround

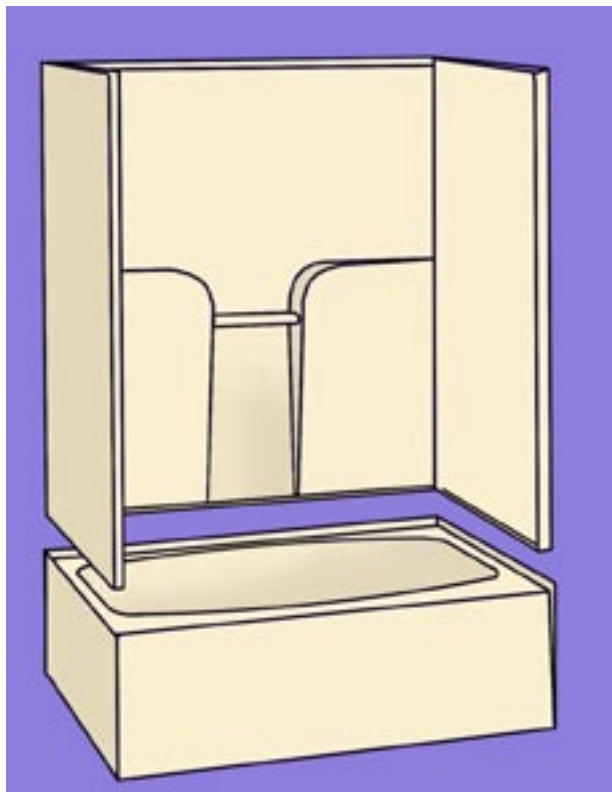

- ▲ 29" x 54" tub
- ▲ Matching 1-pc. surround designed specifically to be used with the 29" x 54" tub.
- ▲ Molded from Gelcoat fiberglass and fully reinforced with fiberglass backing
- ▲ Available in left or right hand drain
- ▲ Twin elevated back wall shelves with acrylic towel bar
- ▲ Textured floor pattern
- ▲ Anti-flex floor construction
- ▲ Complies with ANZI Z 124 Series and HUD/FHA-UM-73a

- 379060** White, LH
- 379061** White, RH
- 379062** Bone, RH
- 379063** Bone, LH

378208 Shower Door for Above



Replacement Rollers for Shower/Tub Doors



378210 Rollers with Screws

Fiberglass Garden Tubs



- 379860** 42" x 60" Bone, No Step
- 379861** 42" x 60" White, No Step
- 379862** 49" x 60" Bone, W/Step
- 379863** 49" x 60" White, W/Step
- 379864** 43" x 54" Bone, W/Step
- 379865** 43" x 54" White, W/Step



Shower Pans & Surrounds

27" x 54" shower pan with surround and all the great design features above.

- 379866** White Pan
- 379867** Bone Pan
- 379868** White Surround
- 379869** Bone Surround

378209 Shower Door for Above



ABS Tubs/Surrounds



These tubs and surrounds are made of ABS plastic and come in calf-grain textures. The strength in these tubs come from injection molded foam bases and formed drain supports. Garden tubs have an additional Masonite bottom sheet for stability. One-year warranty on standard tubs; heavy-duty units have a five-year warranty. Other tub styles and sizes are available by special order.

Regular Tubs



Center Drain

Standard: 27" x 54" x 15-7/8" H (12" Depth)

- 379984** LH White
- 379985** RH White
- 379875** LH White, Boxed
- 379876** RH White, Boxed
- 379978** LH Almond
- 379979** RH Almond
- 379877** LH Almond, Boxed
- 379878** RH Almond, Boxed

W/Center Drain: 27" x 54" x 15-7/8" (11-3/8" Depth)

- 379997** White
- 379999** White; Boxed
- 379998** Almond
- 380000** Almond; Boxed

Heavy-Duty*: 27" x 54" x 15-7/8" H (12" Depth)

- | | |
|--------------------------------|--------------------------------|
| 379970 LH White | 379971 RH White |
| 379627 LH White; Boxed | 379628 RH White; Boxed |
| 379972 LH Almond | 379973 RH Almond |
| 379629 LH Almond; Boxed | 379630 RH Almond; Boxed |



**Heavy-Duty with Center Drain*:
27" x 54" x 15-7/8" H (12" Depth)**

- 379885** White
- 379886** Almond

***5 Yr. Warranty
on Heavy Duty Tubs by BB**



Standard Garden Tub



**W/Outside Step:
40" x 60" x 17-1/16" H
(13-5/8" Depth)**

- 379993** White
- 379994** Almond



Heavy Duty Garden Tubs w/Outside Step



48" x 60" x 21"H (13-5/8" Depth)

- 379982** White
- 379624** White; Boxed
- 379983** Almond
- 379623** Alm.; Boxed

40" x 60" x 17-1/16"H (13-5/8" Depth)

- 379968** Almond
- 379625** Almond; Boxed
- 379969** White
- 379626** White; Boxed

40" x 54" x 17-1/16"H (13-5/8" Depth)

- 379974** Almond
- 379631** Almond; Boxed
- 379975** White
- 379632** White; Boxed

*5 Yr. Warranty
on Heavy Duty Tubs by BB



Garden w/Center Drain:



**42" x 60" x 20-1/4"
(15-1/2" Deep)
Without Step**

- 379995** White
- 379996** Almond



Corner Tubs

**54" x 54"
RH Drain;
17-1/2" Deep**

- 379880** White Tub
- 379881** White Surround



ABS Tubs/Surrounds



Made of durable ABS with a built-in soap dish. Comes tri-folded in individual boxes. Easy to install with adhesive or rivets (not included).

One-Piece Tub Surround

- 379035** Almond for 27" x 54" Standard Tub
- 379036** White for 27" x 54" Standard Tub
- 379037** Almond for 40" x 54" Garden Tub
- 379038** White for 40" x 54" Garden Tub
- 379031** Almond for 40" x 60" Garden Tub
- 379029** White for 40" x 60" Garden Tub

Rivets

- 379033** Almond
- 379034** White

Multi-Piece Surround with Corner Caddies



Three-Piece Tub Surround

Made of durable ABS plastic, the interlocking panels support ease of installation. Easy to install with approved construction adhesive (not included).

- 379105** Almond for 27" x 54" Standard Tub
- 379106** White for 27" x 54" Standard Tub
- 379107** Almond for 40" x 54" Garden Tub
- 379108** White for 40" x 54" Garden Tub
- 379109** Almond for 40" x 60" Garden Tub
- 379110** White for 40" x 60" Garden Tub

Calf-grain finish and tile look. All ABS stock formed for .080 sheet. Flanged lip at bottom for easier installation and straight wall finish. 57-3/4" high. Three-year warranty.

*Please note that by adding the corner caddies to a 40" x 54" tub, for example, the surround now fits as 48" x 60" tub.

- 379040** Almond f/40" x 54" Garden Tub, Sides & Back
- 379041** White for 40" x 54" Garden Tub, Sides & Back
- 379025** Almond f/27" x 54" Std. Tub, Sides & Back
- 379026** White f/27" x 54" Std. Tub, Sides & Back
- 379042** 4" x 3" White Corner Caddies*, 2 Pk.
- 379043** 4" x 3" Almond Corner Caddies*, 2 Pk.

NEW!

*5 Yr. Warranty on Heavy Duty Tubs by BB

Heavy Duty Drop-In Island Tub w/Reversible End Drain



- 379980** 42" x 60" White (14-1/4" Deep)
- 379981** 42" x 60" Almond (14-1/4" Deep)

Prices and Specifications Subject to Change without Notice

Economy Shower Stall

Economically-priced shower stall comes complete with "no caulk" drain, plastic faucet, shower head, handrail, soap dish and curtain. One-piece heavy-gauge plastic walls install quickly without caulk or fitting. Resists mildew and rust. White. 7.0 cubic feet, 32" x 72-3/8" x 32", 27" opening.



- 379024** Shower Stall
- 374115** Drain



Door for Shower Stall

Continuous hinge with integrated handle and drip for easy installation. 27" opening, not recommended for economy shower stall.

- 378205** Shower Door
- 378210** Replacement Rollers with Screws

Bath-Size Shower Pan



Replace any 27" x 54" tub with this new shower pan. Fits in the same space with no plumbing change.

- 379098** Almond RH **379096** White RH
- 379097** Almond LH **379095** White LH



Door for Bath-Size Shower Pan

Sliding track door w/integrated handle and drip for easy installation. Use with 379097-8 and 379095-6 above.

- 378206** Shower Door for 27" x 54" Shower Pan

Prices and Specifications Subject to Change without Notice

Shower Pan



Beveled inside perimeter lets water from the walls flow back into pan. New design also adds strength. 32" x 32".

- 379090** Almond
- 379091** White



Door for 32" Shower Pan

Continuous hinge with integrated handle and drip for easy installation. Use with 379090 and 379091 above.

- 378204** Shower Door for 32" x 32" Shower Pan

- 378210** Replacement Rollers with Screws

Shower Surrounds



Made of durable ABS with a built-in soap dish. Comes in individual boxes. Easy to install with adhesive or rivets (not included).

- 379092** 1-Pc. Almond f/32" x 32" Shower
- 379093** 1-Pc. White f/32" x 32" Shower
- 379099** 3-Pc. White f/54" x 28" Shower Pan
- 379100** 3-Pc. Almond f/54" x 28" Shower Pan



Coastline Tub & Shower Enclosure

Silver satin anodized finish with safety tempered glass enclosure accents any bathroom. Nylon ball bearing rollers, W-type bottom track, wrap around vinyl glazing and 2 single towel bars.

- 378201** 54"; 4/Ctn.
- 378206** For 54" Shower Pan
- 378303** 54" Replacement Sill Track
- 378304** 3/4" Black Rubber Seal
- 378305** 1-1/8" Black Rubber Seal



Replacement Rollers for Shower/Tub Doors

378210 Rollers with Screws

Bath/Tub Repair Kit

Comes with everything for the most demanding repairs to all types of plastics, fiberglass and even enamel bath fixtures. Shower stall cracks can be repaired in minutes.

110235



Don't forget!



Order these with each bathtub; you'll save yourself time and have everything you need for installation.

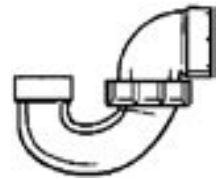

321607 P Trap



321615 P Trap Adapter



374105 Strainer

Tub Trim and Molding

Flange Locks

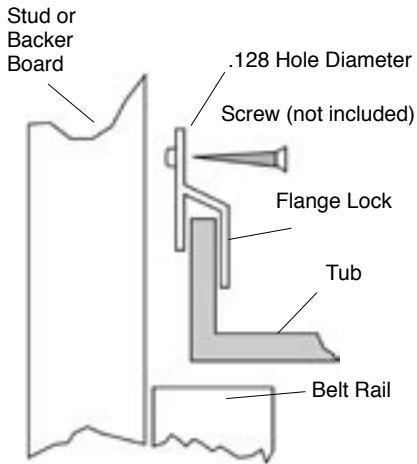

Holds tub or shower pans against wall while allowing environmental expansion and contractions without cracking the tub or shower pan. Stainless steel to prevent rusting or discoloration while providing a strong "spring" action.

Use a minimum of:

- ▲ 3 flange locks per back flange
- ▲ 2 locks per side of tub
- ▲ 3 locks per flange on shower pans

379039

Plastic Tub Molding

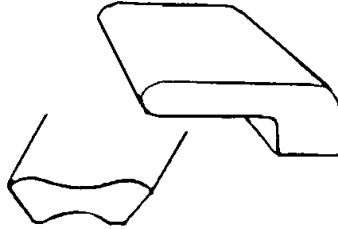

- 265525** Tub, 8' Almond
- 265526** Tub, 8' White
- 265527** Inside Corner, 8' Almond
- 265528** Inside Corner, 8' White

Concave Cove

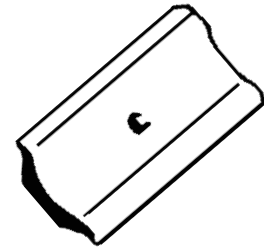

Two 6' 3/4" cove lengths of polished aluminum. 10/Ctn.

265520

Tub Molding

54" set includes 2-28" and 1-53-1/2" length coves, one each of right and left hand ends, and 2 corners. Bagged. 6/Ctn.

265515

Garden Tub Set: 60" set includes 2-48-5/8" and 1-59-1/4" and 2-23-5/8" length coves. Ends and corners.

379919 30/Ctn.

265518 Screws; 50/Box

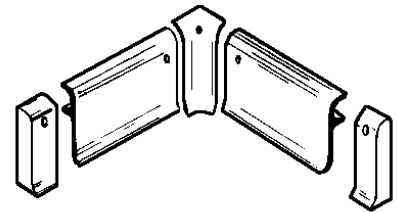

Trim Kits

Kits include: one 60" retainer, three 48" retainers, one 60" molding, four 48" moldings, 2 inside corners and 2 outside corners.

265529 60" Almond Kit

265530 60" White Kit

Kits for 54" include: two 54" retainers, two 54" moldings, 2 inside corners and 2 outside corners.

265531 54" White Kit

265532 54" Almond Kit



Drain Components

Metal Strainer



Metal 4-1/4" flat sink strainer less locknut with grid, large rubber washer and metal washer.

374115 50/Ctn.

Shower Drain



2" PVC shower drain for fiberglass and acrylic showers. Solvent weld.

374116

Bathtub Drain



Chrome 1-1/2" pop-stop drain with positive push-pull seal. Stopper seats and seals with a finger-tip touch. Plug is completely removable for cleaning. Comes with locknut. 50/Ctn.

374107

374109 Gasket for 374107



Rubber Stoppers

379003 1-3/4" ; 72/Ctn.



Tub Basket

2" stainless steel strainer with rubber stopper.

374105 100/Ctn.

Bathtub Drain Pack

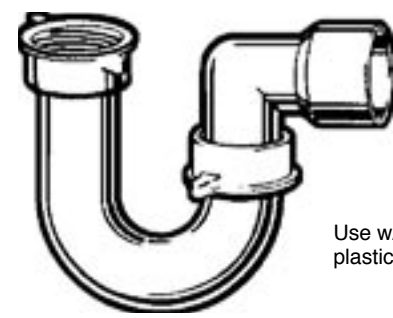

Use w/ABS plastic tubs or

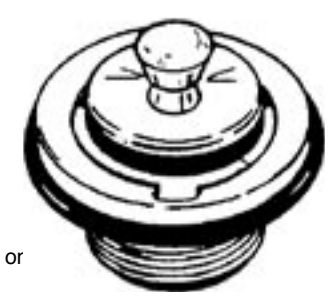

Complete with chrome pop-stop tub drain, ABS P-trap and swivel strainer adapter. 1-1/2".

321614



Toe-Touch Drain

1-1/2" C.P. toe-touch drain, brass.

374110



Flip-It Fit-All Bathtub Stopper

Contains a unique ball-shift toggle system which opens and closes the drain with a simple push of the toe or finger. Fits all 1-3/8" to 1-5/8" tub drains. To install, just affix the included "O" ring and press into drain. Complete with "O" rings and instructions. Chrome in clamshell pack.

*Fits 90% of all tub drain openings!
Needs no tools to install!*

NEW!



374120



*Just press into drain —
and it stays there.....*

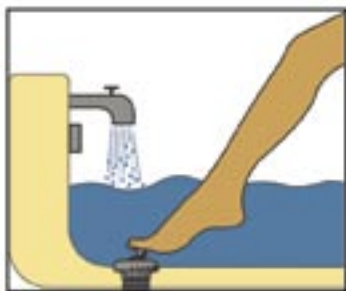

Bath Drain w/Overflow

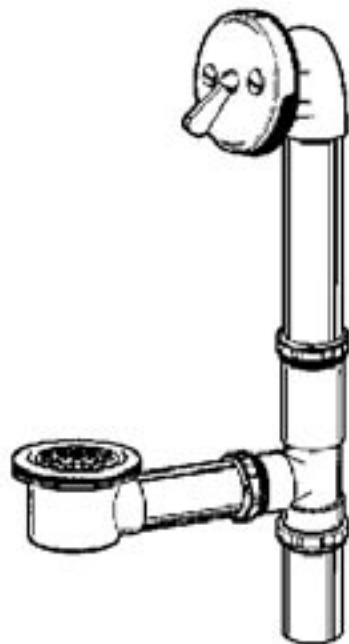

1-1/2" PVC trip lever.

370064

Chrome Tub Replacement Stopper

Polybag with hang hole.

374123

NEW!

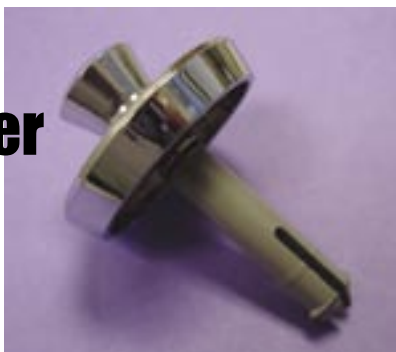

Trap Adapter

w/Washer & Nut

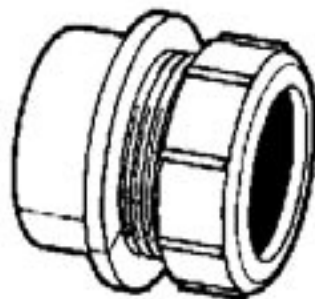

1-1/2" Tub Trap Swivel



320794

Tub Trap Adapter

1-1/2" sp x NPSM. 50/Ctn.

321615

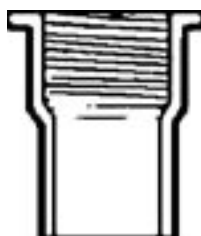

1-1/2" x 1-1/2" or 1-1/2" x 1-1/4" furnished with both size SJ washers. 25/Ctn.

321613

Bath Accessories

Cosmetic Box



Baked white enamel cabinet with triple-plated chrome trim. 24"W x 8"H x 4"D. 8/Ctn.

378126
378127 Replacement Door

Medicine Cabinet

Fits 2" recess; installs with 4 screws. Three metal shelves with 6 different slots for height adjustments. Toothbrush holder. Reversible right or left hand door opening. Rough opening: 14"W x 24"H x 2"D. Overall 16-1/4"W x 26-1/4"H. 4/Ctn.

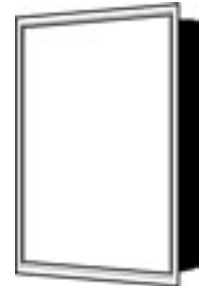

378121

Shower Curtain

Attractive, subtle white patterns on white backgrounds.



378300 12/Ctn.

5-Pc. Chrome Bath Sets



- ▲ 1 large & 1 small towel rack
- ▲ 1 tissue holder
- ▲ 1 soap dish
- ▲ 1 toothbrush/glass holder

370325

Shower Rod



5' polished aluminum rod. Flanges sold separately.

377225 Rod

Wood Medicine Cabinet

Measures 20"W x 4"D x 16"H, all wood with beveled glass mirror. Boxed and bar-coded.



378122 White
378123 Light Oak

Flanges

1' diameter flanges with screws.

377226 2/Bag



Shower Rings

Chrome-plated. 12/Card.

377227



- * Ultra-quiet, U.L. Listed, 115V motor.
- * Vertical exhaust
- * Foam damper for a secure seal when not in operation
- * Simple installation with plug-in motor & lamp, snap-in junction box cover
- * 50 CFM; 8/Ctn.



421206
 #V2244 w/Light;
 7" Rough Opening

Bath Vents

- 421401** Blade Only
- 420103** 115 Volt Motor
- 421207** Replacement Lens
- 421208** Damper

See page I-18 for breakdown and replacement parts.



421201
 #V2262-50 w/out Light; 10-3/4" Rough Opening

Kitchen Sink W/Ledge



Nickel-bearing stainless steel bowls are buffed and complemented by a satin-buffed top deck. Sound deadening material is applied to the bowl base. 4 holes.

- 370015** 33" x 22" OD; 13-7/8" x 15-1/4" Bowl; 6" D
- 373601** 33" x 19" OD; 13" x 14" Bowl; 6" D
- 373603** 33" x 19" OD; 8" D
- 373606** 33" x 19" OD; 7" D



Kitchen Sink - No Ledge



No faucet ledge. Nickel-bearing stainless steel bowls are buffed and complemented by a satin-buffed top deck. Sound deadening material is applied to the bowl base. 6" deep.

- 373599** 33" x 17" OD; 13" x 14" Bowl Size



White Permalux Kitchen Sink



19" x 33" x 7-1/2" deep double bowls in "Permalux Plus" finish: acrylic sink with two-part polyurethane added to the back for added strength. Higher and deeper gloss than fiberglass with permanent gloss retention. Caulked finish looks like one-piece unit. Durable and stain resistant, will not chip, peel or spiderweb. UV protection. Resists scratching and marring. Cleaner/chemical resistant. Four holes. Five-year warranty.

- 373602** White



White Thermoplastic Kitchen Sink



Made with Duramax, a coextruded material comprised of acrylic and ABS, reinforced with a backing containing fiberglass, polyester resins and minerals for added strength. High gloss surface, germ resistant finish, chemical and stain resistant, easy to install. Lightweight but tough.

- 373607** 33" x 19" x 8.5"
- 374100** Basket w/Strainer, White

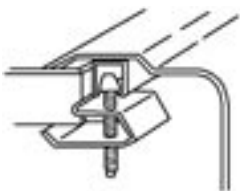

Sink Clips

Stainless steel, self-rimming U channel sink compression clip with screws.

- 373200**



Sink Hole Covers

1-3/4" hole covers for stainless steel.

- 373600**

China Lavatory Sink

17" x 20" oval porcelain drop-in bowl.

- 376815 White
- 376816 Bone



Plastic Lavatory Sink

17" x 20" oval polypropylene, less overflow.

- 376805 White; 8/Ctn.
- 376807 Bone; 8/Ctn.



CO Plug & Drain

Matching CO plug & drain for 376805 & 376807.

- 376806 White
- 376808 Bone

Riser with Nut (Supply Line)



374425 30" x 3/8"

Water Supply Lines for Sinks



- 374417 1/2" x 3/8" Compression 12"
- 374418 1/2" IPS 12"; 10/Ctn.

PVC Basket & Strainer



Plastic 3", with stainless steel ring.

- 374101 48/Ctn.
- 374202 Washer; 50/Ctn.
- 374106 Basket Only

White Plastic Basket & Strainer



374100

Rectangular Lavatory

17" x 20" rectangular lavatory sink, plastic.

- 376804 White
- 376803 Bone

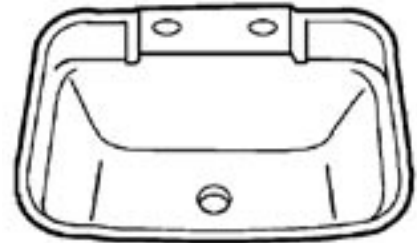

Metal Basket & Strainer



Stainless steel sink strainer to fit sinks with openings.

- 374104 Basket & Strainer; 50/Ctn.
- 374103 Replmt. Basket f/374104
- 374202 Washer; 50/Ctn.
- 374102 3" Basket Only

Adapter Drain & Trap Connector

Installs quickly and easily without special tools, gluing, threading or soldering. Simply place the ends over the pipes and tighten the rust-proof clamps. Connects 1-1/4" or 1-1/2" tubular traps to all common 1-1/4" or 1-1/2" drain piping.



321895 20/Ctn.

Chrome ABS Pop-Up



Use with china lavatories 376815 & 376816.

377204 Carded

CO Plug



1-1/4" x 5" CO plug w/chain and rubber stopper. 25/Ctn.

377201 Chrome

Plastic Stopper f/ 1-Piece CO Plug



377200
Plastic, Almond

377203
Plastic, Chrome

377202 White
NEW!

377205 Gasket

"P" Trap Adapter

Male with washer and nut. 1-1/2" SP X SJ. 300/Ctn.

321606

375004 Bevelled Washer Only



"P" Trap w/Union



ABS 1-1/2" H x H, without CO. 35/Ctn.

321607

Replacement Stoppers



374122 Chrome
374108 Ivory

NEW!

"P" Trap



1-1/2" P-trap, black polypropylene. 25/Ctn.

375203

Dishwasher Drain Connector



Connects dishwasher hose to sink drains and garbage disposals. Elastomeric PVC for years of trouble-free service. 48/Ctn.

321898

Dishwasher Drain Air Gap



Eliminates pressure build-up and possible contamination of water. Durable plastic with intake and discharge tube and a trouble-free air release valve for automatic anti-siphon protection. 5/8" OD inlet x 7/8" OD outlet.

375006

Flat Washer



1.5" rubber; 50/Ctn.

375003

Bevelled Washer



1.5" rubber bevelled washer for use with P-trap adapter 321606.

375004

Adj. Continuous Waste



375001 1-1/2"; 50/Ctn.
375003 Washer

Adj. Continuous Waste w/Tailpiece



375005 1-1/2"; 15/Ctn.
375003 Washer

Brass Drain & Icemaker Valve



1/2" PEX x 1/4" O.D. compression straight valve.

168219

Qwik Elbow



Connects all common household drain, waste & vent pipes quickly without special tools or fittings. Flexible, x-long, ideal for fittings cut out at the joint during alteration or repair. Flexible PVC 3" x 3".

321897

Plumbing Vent



Automatic 1-1/2" vent with adapter. 50/Ctn.

425204

Threaded Nipples

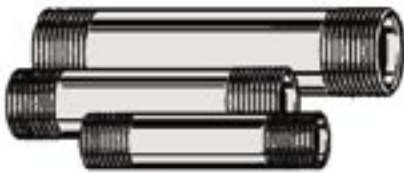

Plastic, 3" dia.; 25/Ctn.

320301 3"

320302 6"

320303 10"

Reducing Elbow

Plastic, 3/4" x 3/4" combination and reducing elbow.

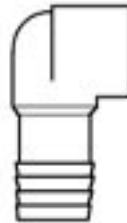

321541 Insert x MPT

Flexible Fittings

- ▲ Elastomeric PVC, not rubber
- ▲ Highly resistant to caustic chemicals and ozone
- ▲ High tear and shear strength
- ▲ Rust-proof Series 300 stainless steel bands including screw and housing to assure easy installation and a positive seal.

Couplers

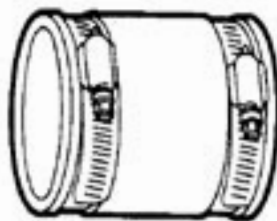

321893 1-1/2"

321892 2"; 10/Ctn.

321890 3"; 10/Ctn.

321891 4"; 10/Ctn.

Reducing Coupler

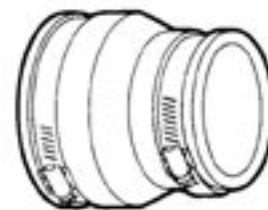

321894 3" to 4"; 10/Ctn.